

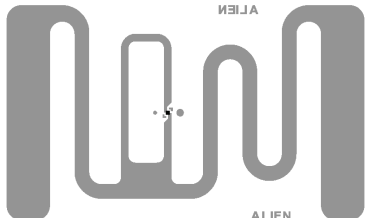

“GT” GARMENT TAG INLAY

The Alien Technology® ALN-9728 “GT” is a 30mm x 50mm RFID inlay specifically designed for high read performance in the retail and apparel markets. This tag has a form-factor especially suitable for hang-tags.



Applications

- Retail
- Apparel
- Hang-tags
- Joker tags
- Labels
- Document tracking

FEATURE	DESCRIPTION	BENEFIT
30mm x 50mm form-factor	Designed to fit the form-factor and everyday retail use cases where items are tightly packed on shelves or hangers	Extremely high read-rates in real-life, every day retail environments
Tuned for use in retail environments with packed shelves or hanging garments		
Next generation Higgs™ 4 features and performance	A mass-market optimized tag with class leading read and write performance. Supports pre-encoded MCS serialization and Aliens <i>BlastWrite</i> ™	Rapid programming of serialized tags and excellent read/write performance

Features:

- › Designed to meet EPCglobal Gen2 (V 1.2.0) and ISO/IEC 18000-6C
- › Worldwide operation in the RFID UHF bands (840-960 MHz)
- › 448-Bits of NVRAM Memory
 - 128-EPC Bits
 - 128 User Bits
 - 64 Bit Unique TID
 - 32 Bit Access and 32 bit Kill Passwords
- › Pre-Programmed with a unique, unalterable 64-bit serial number
- › User Memory can be Block Perma-Locked as well as read password protected in 32 Bit Blocks
- › Class leading read and write performance
- › Pre-encoded Multivendor Chip Serialization (MCS)
- › *BlastWrite*™ and *QuickWrite*™ mass-encoding
- › Dynamic Authentication™ - anti-cloning/anti-counterfeit technology
- › Exceptional operating range, up to 11m with appropriate antenna.
- › Available in high-yield, high capacity dry/wet inlay rolls

Product Overview:

Powered by Alien®’s break-through **Higgs™ 4 UHF RFID IC** and **innovative “GT” antenna design**, the ALN-9728 delivers industry leading EPC Gen 2 performance and reliability for retail and apparel applications where items are tightly packed on shelves or hangers.

With its Higgs-4 core, the “GT” delivers next generation read and write performance, yet is completely **optimized for the highest volume enterprise, retail, and automotive applications.**

An optimized memory footprint includes a 32-bit TID, a **64-bit Unique TID for authentication** and **next generation serialization** applications, a 128-bit EPC memory bank, 128-bits of user memory for distributed data applications, and **password protected read and write** support capabilities to prevent unauthorized viewing and modification of the tag’s data.

ALN-9728 inlays are World Tag compliant, enabling consistent operation across the diverse frequencies of the Americas, Europe, Middle East, Asia, and Africa.



ALN-9728 "GT" Garment Tag Inlay

All dimensions in millimeters unless specified otherwise

ALN-9728 Basic Dimensions

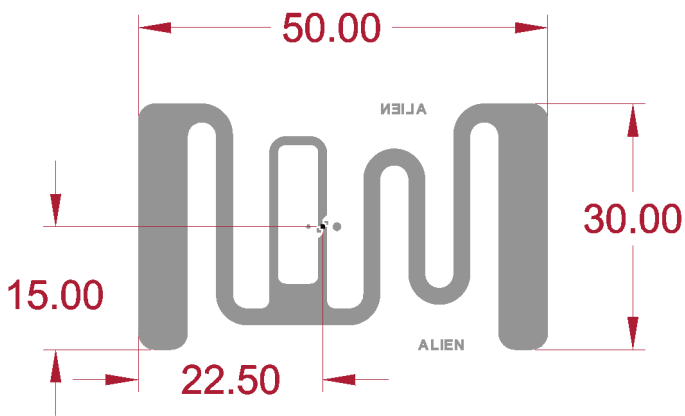

ALN-9728 Dry

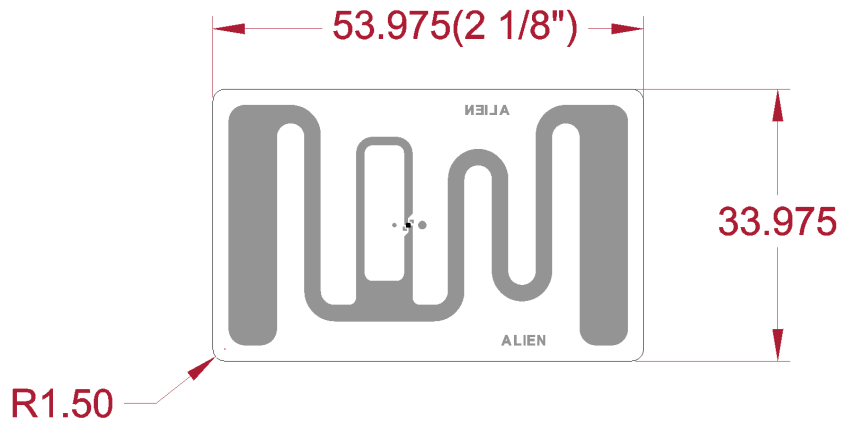

ALN-9728 Wet

ALN-9728 Inlay Orientation

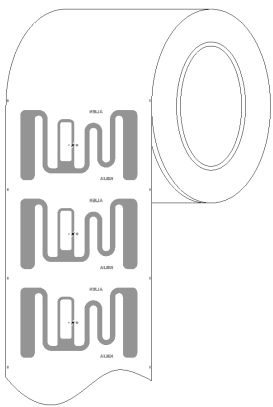

ALN-9728-R (Non-Rotated Dry Unslit Roll) and ALN-9728-SR (Non-Rotated Dry Slit Roll)

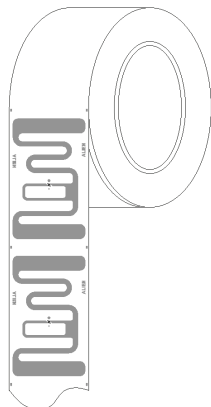

ALN-9728-90SR (Rotated 90° Dry Slit Roll)

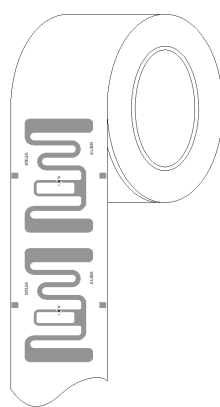

ALN-9728-90R (Rotated 90° Dry Unslit Roll)

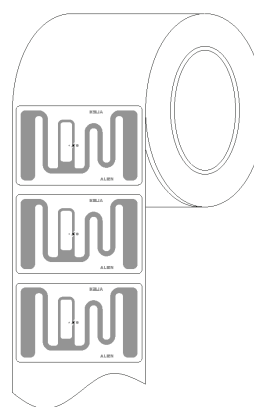

ALN-9728-WRW (White Wet Roll)

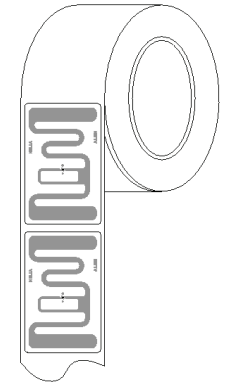

ALN-9728-90WRW (Rotated White Wet Roll)

Standard Alien Inlay rolls unwind with metal antenna side facing outward, with respect to the core.



ALN-9728 Inlay Specification

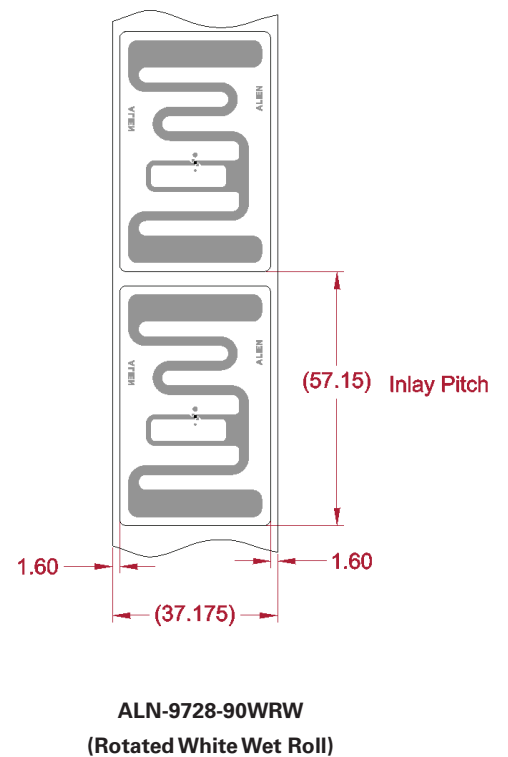
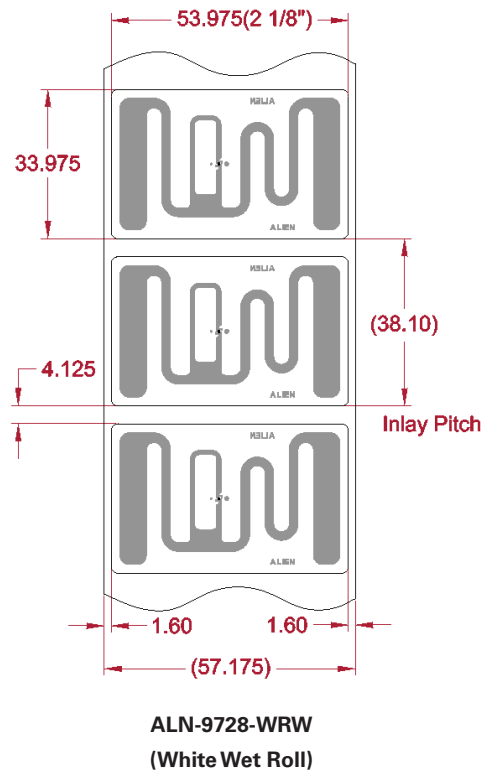
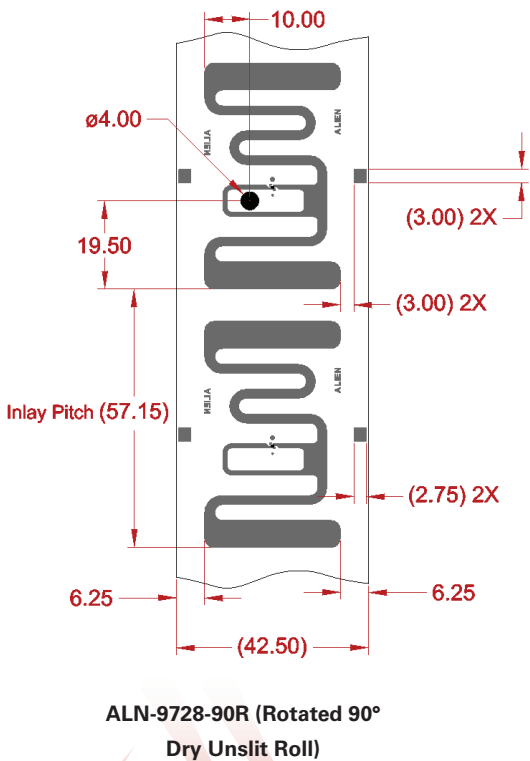
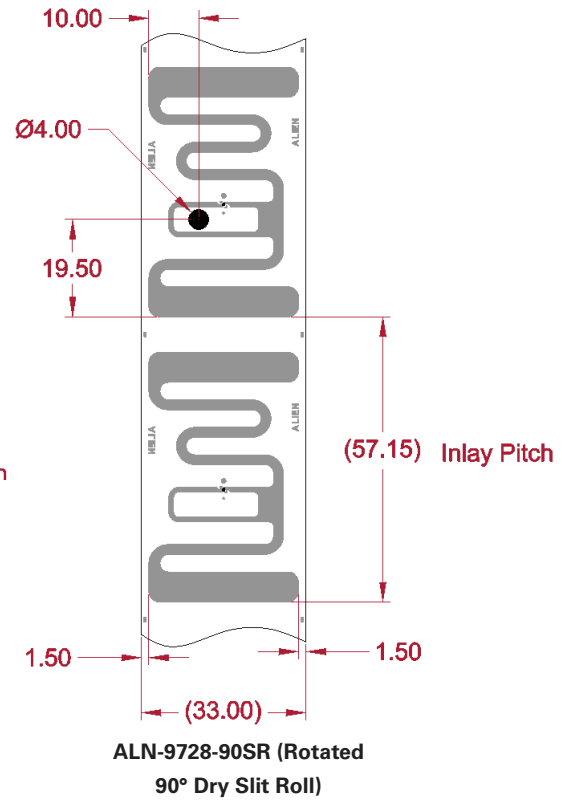
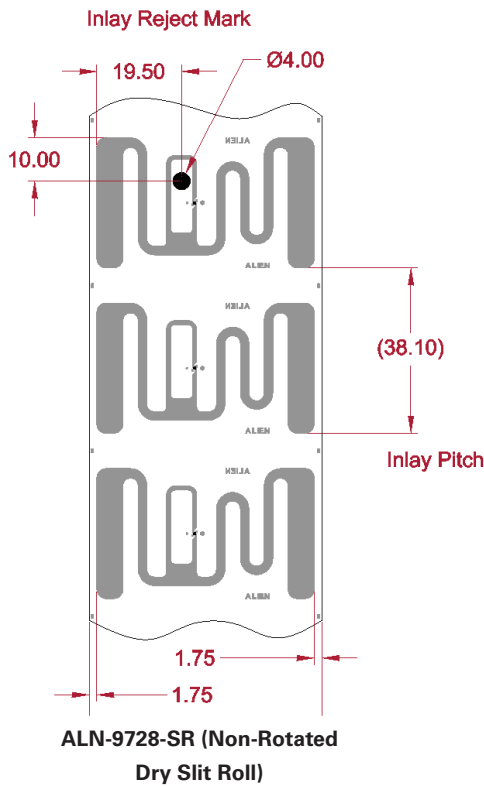
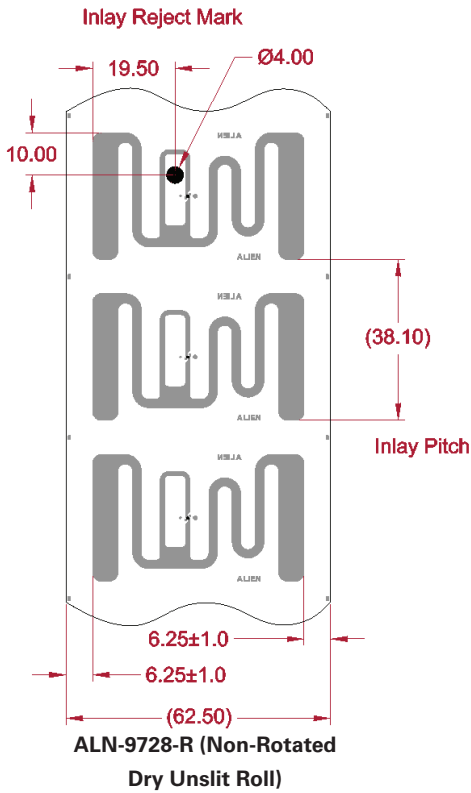



ALN-9728 "GT" Garment Tag Inlay

ALN-9728 Inlay Stackup

DRY INLAY THICKNESS, $\pm 10\%$	
OVER ANTENNA	0.05 mm
OVER CHIP	0.25 mm

WHITE WET INLAY THICKNESS, $\pm 10\%$	
OVER ANTENNA	0.16 mm
OVER CHIP	0.36 mm



ALN-9728-R/90SR/90R

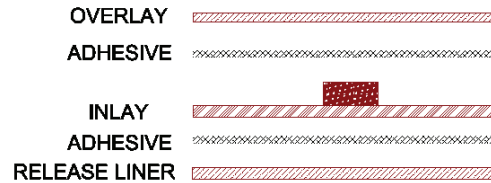

ALN-9728-WRW/90WRW

ALN-9728 Inlay Angular Sensitivity

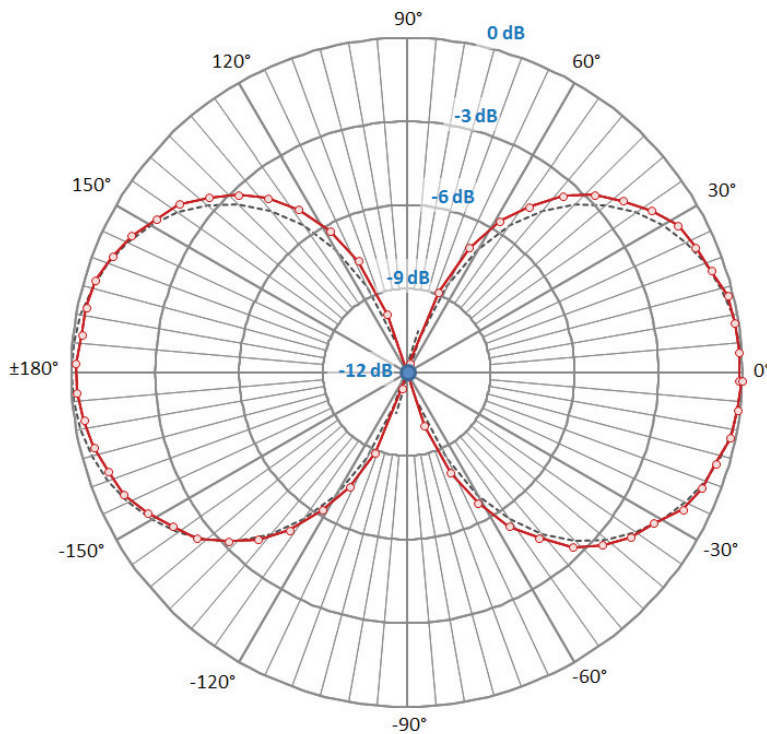

Angular Sensitivity
(Relative Read Range vs. Orientation)

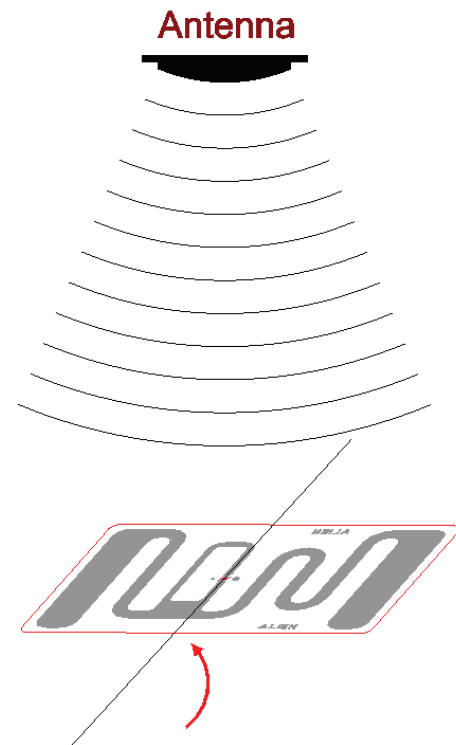

Angular Sensitivity
Inlay is rotated in the x, y, plane about the z axis



ALN-9728 "GT" Garment Tag Inlay

ALN-9728 Specifications

Dry Inlay	Non-Rotated ALN-9728-R	Non-Rotated Slit ALN-9728-SR	Rotated ALN-9728-90SR	Rotated Unslit ALN-9728-90R
Antenna Width	1.97" [50mm]	1.97" [50mm]	1.18" [30mm]	1.18" [30mm]
Antenna Length	1.18" [30mm]	1.18" [30mm]	1.97" [50mm]	1.97" [50mm]
Web/Core Width	2.46" [62.5mm]	2.11" [53.5mm]	1.3" [33mm]	1.67" [42.5mm]
Web Pitch	1.5" [38.1mm]	1.5" [38.1mm]	2.25" [57.15mm]	2.25" [57.15mm]
Core ID	6" [152.4mm]*			
Core Material	Fiberboard			
Inlays per Roll	12,500 Nominal	12,500 Nominal	7,500 Nominal	7,500 Nominal
Maximum Roll OD	< 12" [304.8mm]			
Roll Labeling Data	Roll #, Quantity			

Wet Inlay	Non-Rotated ALN-9728-WRW	Rotated ALN-9728-90WRW
Inlay Width	2.125" [53.975mm]	1.34" [33.975mm]
Inlay Length	1.34" [33.975mm]	2.125" [53.975mm]
Web Width	2.25" [57.175mm]	1.46" [37.175mm]
Web Pitch	1.5" [38.1mm]	2.25" [57.15mm]
Core Width	2.25" [57.175mm]	1.46" [37.175mm]
Core ID	6" [152.4mm]*	
Core Material	Fiberboard	
Inlays per Roll	11,500 Nominal	7,500 Nominal
Maximum Roll OD	< 16" [406.4mm]	< 16" [406.4mm]
Roll Labeling Data	Roll #, Quantity	
White	TT Printable White Film Only	
Overlay Adhesive	General Purpose Permanent	
Inlay Adhesive	General Purpose Permanent	
Adhesive Application Temperature	> +25°F [-4°C]	
Adhesive Service Temperature	-40°F to +200°F [-40°C to +93.3°C]	
Release Liner	40# SCK	

* Shipped with 6" to 3" plastic core adapter

Environmental	
Shelf Life	2 years at +77°F [+25°C] @ 40%RH
Recommended Storage	+77°F [+25°C] @ 40% RH
Storage Limits	-13°F to 122°F [-25°C to +50°C] 20% to 90% RH Non-condensing
Operating Limits	-40°F to +158°F [-40°C to +70°C] 20% to 90% RH Non-condensing
Bend Diameter	> 1.97" [50mm]
Pressure	< 5N/mm ²
Drop Resistance	Per ASTM D5276
Write Cycles	100,000 @ 25°C
RoHs	2002/95/EC, 2005/618/EC, 2011/65/EU Compliant
REACH	1907/2006/EC Compliant (SVHC and ECHA)
ESD Limit- HBM / CDM	5.0kV / 1.5kV

RFID	
Protocols Supported	ISO/IEC 18000-6C EPCglobal Class 1 Gen 2
Integrated Circuit	Alien Higgs-4
Operating Frequency	840-960 MHz
EPC Size	128 Bits
User Memory	128 Bits
TID	32 Bits
Unique TID	64 Bits
Access Password	32 Bits
Kill Password	32 Bits

Copyright © 2015 Alien Technology LLC. All rights reserved.

Alien, Alien Technology, the Alien Technology logo, FSA, Higgs, Dynamic Authentication, QuickWrite, BlockWrite, Squiggle, and the Squiggle logo are trademarks or registered trademarks of Alien Technology Corporation in the U.S. and other countries.

HANDLING PRECAUTIONS Observe standard handling practices to minimize ESD.

DISCLAIMER Application recommendations are guidelines only - actual results may vary and should be confirmed. This is a general purpose product not designed or intended for any specific application.

This product is covered by one or more of the following U.S. patents: 7967204, 7931063, 7868766, 7737825, 7716208, 7716160, 7688206, 7659822, 7619531, 7615479, 7598867, 7580378, 7576656, 7562083, 7561221, 7559486, 7559131, 7554451, 7551141, 7542301, 7542008, 7531218, 7522055, 7500610, 7480248, 7453705, 7425467, 7417306, 7411503, 7385284, 7377445, 7364084, 7353598, 7342490, 7324061, 7321159, 7301458, 7295114, 7288432, 7265675, 7262686, 7260882, 7253735, 7244326, 7218527, 7214569, 7199527, 7193504, 7173528, 7172910, 7172789, 7141176, 7113250, 7101502, 7080444, 7070851, 7068224, 7046328, 6998644, 6988667, 6985361, 6980184, 6970219, 6952157, 6942155, 6933848, 6927085, 6816380, 6780606, 6731353, 6693384, 6683663, 6665044, 6657289, 6623579, 6606247, 6606079, 6590346, 6586338, 6566744, 6555408, 6527964, 6479395, 6468638, 6420266, 6316278, 6291896, 6281038. Other patents pending.

This product is licensed under patents of Round Rock Research, LLC, for use solely with UHF RFID Readers (such as Alien reader products) that are licensed under an agreement with Round Rock Research, LLC.

November 5, 2014



Alien Technology
18220 Butterfield Blvd.
Morgan Hill, CA 95037
866-RFID NOW
www.alientechnology.com